

Keysight U8903A Audio Analyzer

Notice: This document contains references to Agilent. Please note that Agilent's Test and Measurement business has become Keysight Technologies. For more information, go to www.keysight.com.

Notices

Copyright Notice

© Keysight Technologies 2011–2016

No part of this manual may be reproduced in any form or by any means (including electronic storage and retrieval or translation into a foreign language) without prior agreement and written consent from Keysight Technologies as governed by United States and international copyright laws.

Manual Part Number

U8903-90032

Edition

Edition 8, April 1, 2016

Printed in:

Printed in Malaysia

Published by:

Keysight Technologies
Bayan Lepas Free Industrial Zone,
11900 Penang, Malaysia

Technology Licenses

The hardware and/or software described in this document are furnished under a license and may be used or copied only in accordance with the terms of such license.

Declaration of Conformity

Declarations of Conformity for this product and for other Keysight products may be downloaded from the Web. Go to <http://www.keysight.com/go/conformity>. You can then search by product number to find the latest Declaration of Conformity.

U.S. Government Rights

The Software is “commercial computer software,” as defined by Federal Acquisition Regulation (“FAR”) 2.101. Pursuant to FAR 12.212 and 27.405-3 and Department of Defense FAR Supplement (“DFARS”) 227.7202, the U.S. government acquires commercial computer software under the same terms by which the software is customarily provided to the public. Accordingly, Keysight provides the Software to U.S. government customers under its standard commercial license, which is embodied in its End User License Agreement (EULA), a copy of which can be found at <http://www.keysight.com/find/sweula>. The license set forth in the EULA represents the exclusive authority by which the U.S. government may use, modify, distribute, or disclose the Software. The EULA and the license set forth therein, does not require or permit, among other things, that Keysight: (1) Furnish technical information related to commercial computer software or commercial computer software documentation that is not customarily provided to the public; or (2) Relinquish to, or otherwise provide, the government rights in excess of these rights customarily provided to the public to use, modify, reproduce, release, perform, display, or disclose commercial computer software or commercial computer software documentation. No additional government requirements beyond those set forth in the EULA shall apply, except to the extent that those terms, rights, or licenses are explicitly required from all providers of commercial computer software pursuant to the FAR and the DFARS and are set forth specifically in writing elsewhere in the EULA. Keysight shall be under no obligation to update, revise or otherwise modify the Software. With respect to any technical data as defined by FAR 2.101, pursuant to FAR 12.211 and 27.404.2 and DFARS 227.7102, the U.S. government acquires no greater than Limited Rights as defined in FAR 27.401 or DFAR 227.7103-5 (c), as applicable in any technical data.

Warranty

THE MATERIAL CONTAINED IN THIS DOCUMENT IS PROVIDED “AS IS,” AND IS SUBJECT TO BEING CHANGED, WITHOUT NOTICE, IN FUTURE EDITIONS. FURTHER, TO THE MAXIMUM EXTENT PERMITTED BY APPLICABLE LAW, KEYSIGHT DISCLAIMS ALL WARRANTIES, EITHER EXPRESS OR IMPLIED, WITH REGARD TO THIS MANUAL AND ANY INFORMATION CONTAINED HEREIN, INCLUDING BUT NOT LIMITED TO THE IMPLIED WARRANTIES OF MERCHANTABILITY AND FITNESS FOR A PARTICULAR PURPOSE. KEYSIGHT SHALL NOT BE LIABLE FOR ERRORS OR FOR INCIDENTAL OR CONSEQUENTIAL DAMAGES IN CONNECTION WITH THE FURNISHING, USE, OR PERFORMANCE OF THIS DOCUMENT OR OF ANY INFORMATION CONTAINED HEREIN. SHOULD KEYSIGHT AND THE USER HAVE A SEPARATE WRITTEN AGREEMENT WITH WARRANTY TERMS COVERING THE MATERIAL IN THIS DOCUMENT THAT CONFLICT WITH THESE TERMS, THE WARRANTY TERMS IN THE SEPARATE AGREEMENT SHALL CONTROL.

Safety Information

CAUTION











A CAUTION notice denotes a hazard. It calls attention to an operating procedure, practice, or the like that, if not correctly performed or adhered to, could result in damage to the product or loss of important data. Do not proceed beyond a CAUTION notice until the indicated conditions are fully understood and met.

WARNING

A WARNING notice denotes a hazard. It calls attention to an operating procedure, practice, or the like that, if not correctly performed or adhered to, could result in personal injury or death. Do not proceed beyond a WARNING notice until the indicated conditions are fully understood and met.

Safety Symbols

The following symbols on the instrument and in the documentation indicate precautions which must be taken to maintain safe operation of the instrument.

	Direct current (DC)		Equipment protected throughout by double insulation or reinforced insulation
	Alternating current (AC)		Off (supply)
	On (supply)		Caution, risk of electric shock
	Earth (ground) terminal		Caution, risk of danger (refer to this manual for specific Warning or Caution information)
	Protective conductor terminal		Frame or chassis terminal

Safety Considerations

The following general safety precautions must be observed during all phases of operation of this instrument. Failure to comply with these precautions or with specific warnings elsewhere in this manual violates safety standards of design, manufacture, and intended use of the instrument. Keysight Technologies, Inc. assumes no liability for the customer's failure to comply with these requirements.

WARNING

- Ground the equipment.
For Safety Class 1 equipment (equipment having a protective earth terminal), an uninterruptible safety earth ground must be provided from the mains power source to the product input wiring terminals or supplied power cable.
 - DO NOT operate the product in an explosive atmosphere or in the presence of flammable gases or fumes. For continued protection against fire, replace the line fuse(s) only with fuse(s) of the same voltage and current rating and type. DO NOT use repaired fuses or short-circuited fuse holders.
 - Keep away from live circuits.
Operating personnel must not remove equipment covers or shields. Procedures involving the removal of covers or shields are for use by service-trained personnel only. Under certain conditions, dangerous voltages may exist even with the equipment switched off. To avoid dangerous electric shock, DO NOT perform procedures involving cover or shield removal unless you are qualified to do so.
 - DO NOT operate damaged equipment.
If the built-in safety protection features have been impaired through physical damage, excessive moisture, or any other reason, REMOVE POWER and do not use the product until safe operation is verified by service-trained personnel. If necessary, return the product to Keysight for service and repair to ensure that the safety features are maintained.
 - DO NOT service or adjust alone.
Do not attempt any internal service or adjustment unless a person capable of rendering first aid and resuscitation is present.
-

WARNING

- DO NOT substitute parts or modify equipment. To avoid the occurrence of additional hazards, do not install substitute parts or perform any unauthorized modification to the product. Return the product to Keysight for service or repair to ensure that the safety features are maintained.
- This equipment is under CAT 1 measurement category; do not connect the cable to MAIN.



CAT 1
Maximum Working Voltage: 200 Vp for altitude up to
3000 m
Maximum Transient Voltage: 1210 V

- Do not measure more than the rated voltage (as marked on the equipment).
-

CAUTION

- Use the device with the cables provided.
 - Repair or service that is not covered in this manual should only be performed by qualified personnels.
 - Observe all markings on the device before establishing any connection.
 - Always use dry cloth to clean the device. Do not use ethyl alcohol or any other volatile liquid to clean the device.
 - Do not permit any blockage of the ventilation holes of the device.
-

NOTE

The U8903A Audio Analyzer complies with the following safety and EMC requirements.





- IEC 61010-1:2001/EN 61010-1:2001 (2nd Edition)
 - Canada: CAN/CSA-C22.2 No. 61010-1-04
 - Canada: ICES/NMB-001:Issue 4, June 2006
 - IEC 61326-1:2005/EN 61326-1:2006
 - Australia/New Zealand: AS/NZS CISPR11:2004
 - USA: ANSI/UL std No. 61010-1:2004
-

Environmental Conditions

This instrument is designed for indoor use and in an area with low condensation. The table below shows the general environmental requirements for this instrument.

Environmental condition	Requirement
Operating temperature	0 °C to 55 °C
Operating humidity	20% to 80% RH noncondensing at 40 °C
Storage temperature	-40 °C to 70 °C
Storage humidity	20% to 80% RH noncondensing at 65 °C

Regulatory Markings

 <p>The CE mark is a registered trademark of the European Community. This CE mark shows that the product complies with all the relevant European Legal Directives.</p>	 <p>The RCM mark is a registered trademark of the Spectrum Management Agency of Australia. This signifies compliance with the Australia EMC Framework regulations under the terms of the Radio Communication Act of 1992.</p>
<p>ICES/NMB-001</p> <p>ICES/NMB-001 indicates that this ISM device complies with the Canadian ICES-001. Cet appareil ISM est conforme a la norme NMB-001 du Canada.</p>	 <p>This instrument complies with the WEEE Directive (2002/96/EC) marking requirement. This affixed product label indicates that you must not discard this electrical or electronic product in domestic household waste.</p>
 <p>The CSA mark is a registered trademark of the Canadian Standards Association.</p>	 <p>This symbol indicates the time period during which no hazardous or toxic substance elements are expected to leak or deteriorate during normal use. Forty years is the expected useful life of the product.</p>

Waste Electrical and Electronic Equipment (WEEE) Directive 2002/96/EC

This instrument complies with the WEEE Directive (2002/96/EC) marking requirement. This affixed product label indicates that you must not discard this electrical or electronic product in domestic household waste.

Product category:

With reference to the equipment types in the WEEE directive Annex 1, this instrument is classified as a “Monitoring and Control Instrument” product.

The affixed product label is as shown below.



Do not dispose in domestic household waste.

To return this unwanted instrument, contact your nearest Keysight Service Center, or visit <http://about.keysight.com/en/companyinfo/environment/takeback.shtml> for more information.

Sales and Technical Support

To contact Keysight for sales and technical support, refer to the support links on the following Keysight websites:

- www.keysight.com/find/U8903A
(product-specific information and support, software and documentation updates)
- www.keysight.com/find/assist
(worldwide contact information for repair and service)

Table of Contents

Safety Symbols	3
Safety Considerations	4
Environmental Conditions	6
Regulatory Markings	7
Waste Electrical and Electronic Equipment (WEEE) Directive	
2002/96/EC	8
Product category:	8
Sales and Technical Support	8
Introduction	15
LXI Class-C Compliant Audio Analyzer	16
Installation and Configuration	16
Initial inspection	16
Ventilation	16
Rack mounting	17
Standard Shipped Items	17
Optional Items	18
U8903A Digital Audio	18
U8903A options	18
Units for digital audio measurements	19
Product at a Glance	20
Front panel outlook	20
Rear panel outlook	22
LCD display layout	25
Power On the U8903A	26
Preset the U8903A	26
Help System	27
Using the Editing Keys	28
Switching to 2-Panel or 4-Panel View	30
Switching to Generator/Analyzer and Analog/Digital Mode	31

THIS PAGE HAS BEEN INTENTIONALLY LEFT BLANK.

List of Figures

Figure 1-1	U8903A front panel	20
Figure 1-2	U8903A rear panel (Option 200)	22
Figure 1-3	U8903A rear panel (Option 113, 114, and 115)	22
Figure 1-4	Connect the TOSLINK cable straight into the connector	24
Figure 1-5	U8903A LCD display layout	25
Figure 1-6	Help information dialog	27
Figure 1-7	Editing keys	28
Figure 1-8	2-panel view display	30
Figure 1-9	4-panel view display	30
Figure 1-10	Analog generator	31
Figure 1-11	Digital generator	31
Figure 1-12	Analog analyzer	32
Figure 1-13	Digital analyzer	32

THIS PAGE HAS BEEN INTENTIONALLY LEFT BLANK.

List of Tables

Table 1-1	Units for digital audio measurements	19
Table 1-2	U8903A front panel description	20
Table 1-3	U8903A rear panel description	23
Table 1-4	Active channel indicator	25
Table 1-5	Editing keys description	29

THIS PAGE HAS BEEN INTENTIONALLY LEFT BLANK.

Introduction

The U8903A is a powerful, multichannel audio measurement system that combines both generator and analyzer.

The standard option for the U8903A audio analyzer is Option 200. The U8903A can be further expanded with digital audio interfaces such as the AES3, SPDIF, and Digital Serial Interface (DSI). The digital audio interfaces are available with the U8903A Option 113, 114, and 115. Refer to “**U8903A options**” on page 18 for more information on the available U8903A options.

The U8903A is capable of performing a wide range of audio parameter measurements on both analog audio and digital audio interfaces. Measurement functions can be performed simultaneously on the analog audio and digital audio interfaces such as analog audio + AES3/SPDIF, analog audio + DSI, and AES3/SPDIF + DSI.

The U8903A standard features are as follows.

- The analog generator has a frequency range of 5 Hz to 80 kHz, and the digital generator has a frequency range of 2 Hz to 0.45 sampling rate
- The DSI digital generator has a sampling range of 6.75 kHz to 400 kHz, and the AES3/SPDIF digital generator has a sampling range of 28 kHz to 192 kHz
- The analog analyzer has a frequency measurement range of 10 Hz to 100 kHz and the digital analyzer has a frequency measurement range of 5 Hz to 0.45 sampling rate
- Frequency domain and time domain graph display of the signal
- Sweep capability
- GPIB, LAN, and USB remote interfaces

NOTE

- Refer to the *U8903A Audio Analyzer User's Guide* for more information.
 - To search for firmware updates for the U8903A, go to the Keysight U8903A firmware upgrade website at www.keysight.com/find/audioanalyzer_firmware.
-

LXI Class-C Compliant Audio Analyzer



The U8903A audio analyzer is an **LXI Class-C** compliant instrument, developed using LXI Technology. LXI, an acronym for LAN eXtension for Instrumentation, is an instrument standard for devices that use the Ethernet (LAN) as their primary communication interface.

Hence, it is an easy-to-use instrument especially with the usage of an integrated Web browser that provides a convenient way to configure the instrument's functionality.

Installation and Configuration

Initial inspection

When you receive your U8903A, inspect the unit for any obvious damage such as broken terminals or cracks, dents, and scratches on the chassis that may occur during shipment. If any damage is found, notify the nearest Keysight Sales Office immediately.

Keep the original packaging in case the U8903A has to be returned to Keysight in the future. If you return the U8903A for service, attach a tag identifying the owner and model number. Also, include a brief description of the problem.

Ventilation

The U8903A can operate within the temperature range of 0 °C to 55 °C. The U8903A is cooled by drawing air through the sides and bottom at the front of the U8903A, and exhausting it through the ventilation holes on the sides and top at the rear of the U8903A. The U8903A must be installed in a location that allows sufficient space at the top, sides, and rear for adequate air circulation.

Rack mounting

The U8903A can be mounted in a standard 19-inch rack. Rackmount kits are available as Option 908. Support rails are also required for rack mounting. These are normally supplied with the rack and are not included with the rackmount options.

If you are installing an instrument on top of the U8903A, ensure that the instrument does not obstruct the ventilation holes at the top of the U8903A. If required, use a filler panel above the U8903A to ensure adequate space for air circulation.

Standard Shipped Items

Verify that you have received the following items. If anything is missing or damaged, please contact the nearest Keysight Sales Office.

- U8903A Audio Analyzer
- Power cord
- Shielded LAN cable
- USB cable
- Keysight U8903A Audio Analyzer Quick Start Guide
- Keysight U8903A Audio Analyzer Product Reference CD-ROM
- Certificate of Calibration

Optional Items

The following accessories are available for purchase separately.

- Male BNC to male BNC cable, 1.2 m
- Male BNC to male RCA cable, 2 m
- Male XLR to female XLR cable, 2 m
- Rackmount kit
- Digital serial interface cable

U8903A Digital Audio

U8903A options

U8903A Option 200

The U8903A Option 200 is the standard option with two channels of analog audio generator and analyzer.

U8903A Option 113

The U8903A Option 113 expands the audio analyzer with the AES3, SPDIF, and DSI digital audio interfaces.

U8903A Option 114

The U8903A Option 114 expands the audio analyzer with the AES3 and SPDIF digital audio interfaces.

U8903A Option 115

The U8903A Option 115 expands the audio analyzer with the DSI digital audio interface.

Units for digital audio measurements

Table 1-1 **Units for digital audio measurements**

Unit	Description
FFS	Fractional of Full Scale
%FS	Percent of Full Scale
dBFS	Decibels relative to Full Scale
LSB	Least Significant Bit
FS/Vrms	Ratio between cross-domain input and output levels measurements (analog input and digital output)
Vrms/FS	Ratio between cross-domain input and output levels measurements (digital input and analog output)

Product at a Glance

Front panel outlook

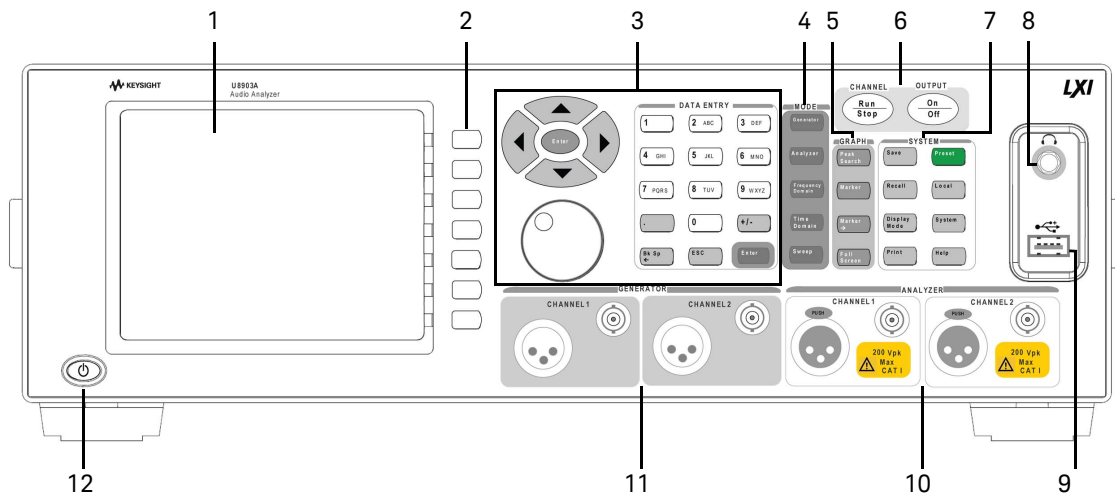

Figure 1-1 U8903A front panel

Table 1-2 U8903A front panel description

No.	Item	Description
1	LCD display	Provides information on the current function including status indicators, settings, and error messages
2	Softkeys 1 to 7	Activates the function as displayed on the right side of the LCD display
3	Editing keys	The editing keys consists of the knob, Enter key, arrow keys, and data entry keys
4	Mode	Enables access to the U8903A main functions such as Generator, Analyzer, Frequency Domain, Time Domain, and Sweep
5	Graph	Enables access to the commonly used graph functions such as Peak Search, Marker, Marker →, and Full Screen

Table 1-2 U8903A front panel description (continued)

No.	Item	Description
6	Channel/Output	Toggles the Run/Stop key to start or stop signal generation or measurements for the selected generator or analyzer channel respectively. The On/Off key toggles on or off the generator output for all active channels.
7	System	Enables access to the U8903A system functions
8	Headphone jack	Reserved for future expansion
9	USB port	Allows an external USB flash storage to be connected to the U8903A
10	Analog analyzer input	Receives analog audio signal using a female XLR input connector and a female BNC input connector. The input connectors are available for each channel.
11	Analog generator output	Outputs analog audio signal using a male XLR output connector and a female BNC output connector. The output connectors are available for each channel.
12	Power on/off	Turns the U8903A on or off

Rear panel outlook

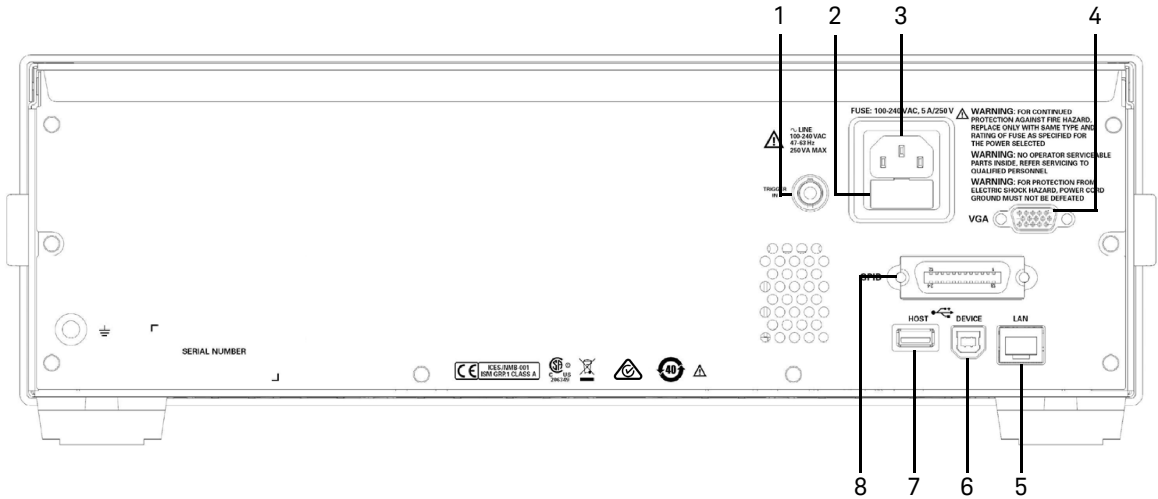

Figure 1-2 U8903A rear panel (Option 200)

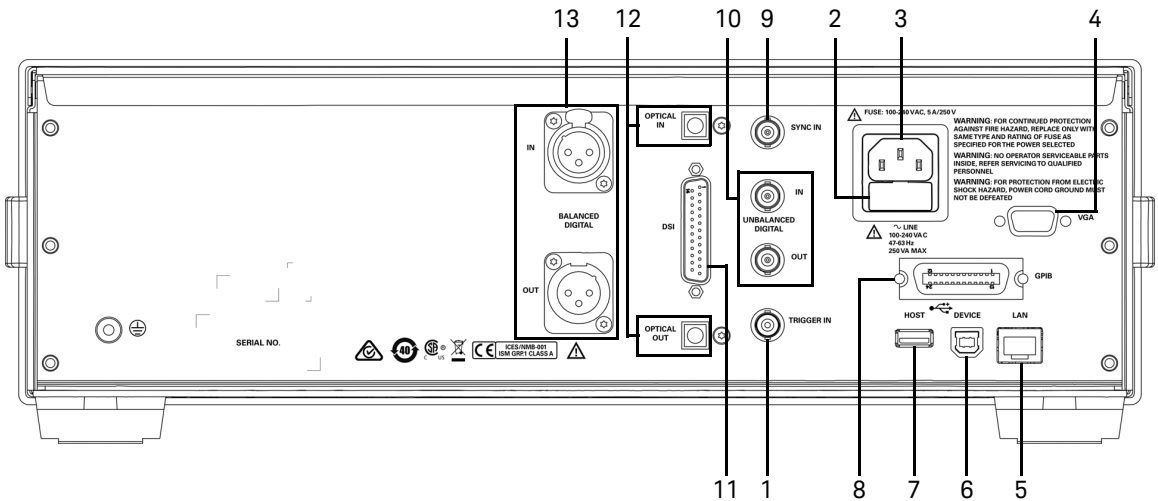

Figure 1-3 U8903A rear panel (Option 113, 114, and 115)

Table 1-3 U8903A rear panel description

No.	Item	Description
1	Trigger in	Receives an external TTL or CMOS signal using a female BNC input connector for triggering operation. Triggering can occur on either the positive or negative edge.
2	Fuse	Fuse compartment for AC supply
3	AC power inlet	Connects to an AC line voltage
4	VGA port	Allows an external monitor to be connected to the U8903A
5	LAN port	Allows the U8903A to be controlled remotely over the LAN interface. Recommended to use a shielded LAN cable.
6	USB Type-B port	Allows the U8903A to be controlled remotely over the USB interface
7	USB port	Allows an external USB flash storage to be connected to the U8903A
8	GPIB port	Allows the U8903A to be controlled remotely over the General Purpose Interface Bus (GPIB) interface
9	Sync in	Receives an external sync in clock/frame signal using a female BNC input connector (for digital audio only)
10	Digital analyzer input and output (AES3/SPDIF)	Receives and outputs digital audio signal using a female BNC input connector and a female BNC output connector respectively
11	Digital analyzer input and output (DSI)	Receives and outputs digital audio signals using a 25-pin male D-SUB connector
12	Digital analyzer input and output (SPDIF)	Receives and outputs digital audio signal using a TOSLINK input connector and a TOSLINK output connector respectively
13	Digital analyzer input and output (AES3)	Receives and outputs digital audio signal using a female XLR input connector and a male XLR output connector respectively

CAUTION

Connect the TOSLINK cable straight into the TOSLINK connector. DO NOT force the cable in or connect at an angle. Failing to do so may cause damage to the TOSLINK connector.

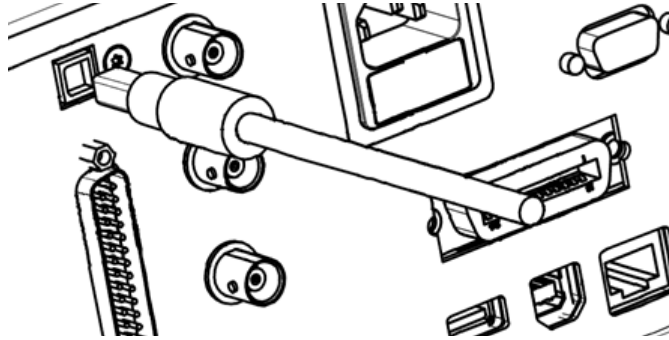

Figure 1-4 Connect the TOSLINK cable straight into the connector

LCD display layout

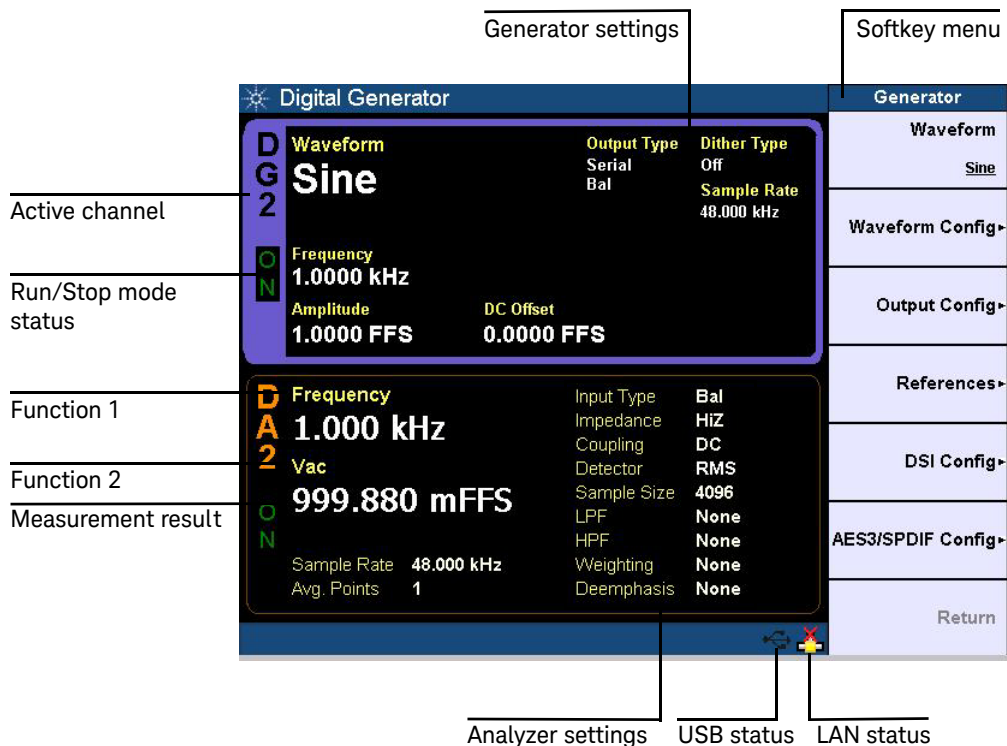

Figure 1-5 U8903A LCD display layout

Table 1-4 Active channel indicator

AG1/AG2	Analog generator channel 1 or 2
AA1/AA2	Analog analyzer channel 1 or 2
DG1/DG2	Digital generator channel 1 or 2
DA1/DA2	Digital analyzer channel 1 or 2

NOTE

Refer to **“Switching to 2-Panel or 4-Panel View”** on page 30 for more information on the U8903A display layout.

Power On the U8903A

Connect one end of the power cord to the U8903A rear panel AC power inlet and the other end to an AC voltage source. The U8903A will automatically adjust to the correct line voltage in the range of 100 Vac to 240 Vac.

Preset the U8903A

A preset does not erase the flash memory, state memory, or I/O configuration. A preset will delete all customized settings on the U8903A.

To preset the U8903A, you can perform either one of the following steps.

- Send the ***RST**, **SYSTem:PRESet**, **SYSTem:RESet[:MODE]**, or **SYSTem:RESet:CHANnel** SCPI commands from the PC via the USB, GPIB, or LAN interface.
- Press  on the System panel.

NOTE

Presetting the U8903A will not reset the HP8903B configurations and the Legacy Sweep setting.

Help System

The help system provides you quick access to the operating information you require.

The **Help** key displays the description of all the front panel keys and current softkeys.

To activate the help mode, press **Help**.

To deactivate, press **ESC**.

NOTE

When Help is enabled, the function keys will not execute their normal functions when pressed.

An example of a help information dialog is shown in [Figure 1-6](#).

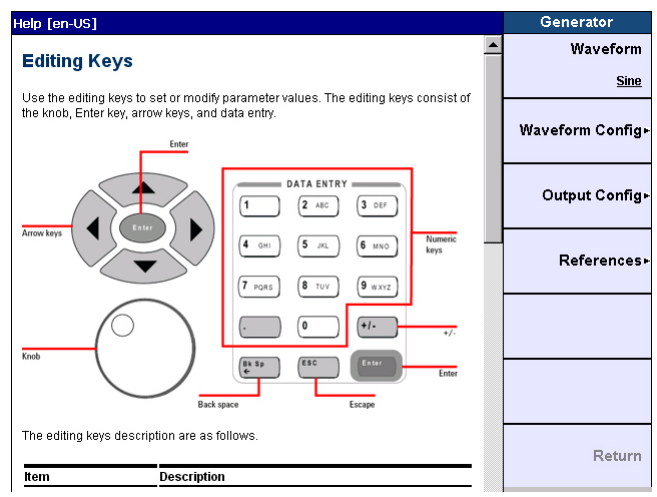

Figure 1-6 Help information dialog

Using the Editing Keys

Editing keys are used to set or modify the parameter values. The editing keys group consists of the knob, Enter key, arrow keys, and data entry keys as shown in [Figure 1-7](#).

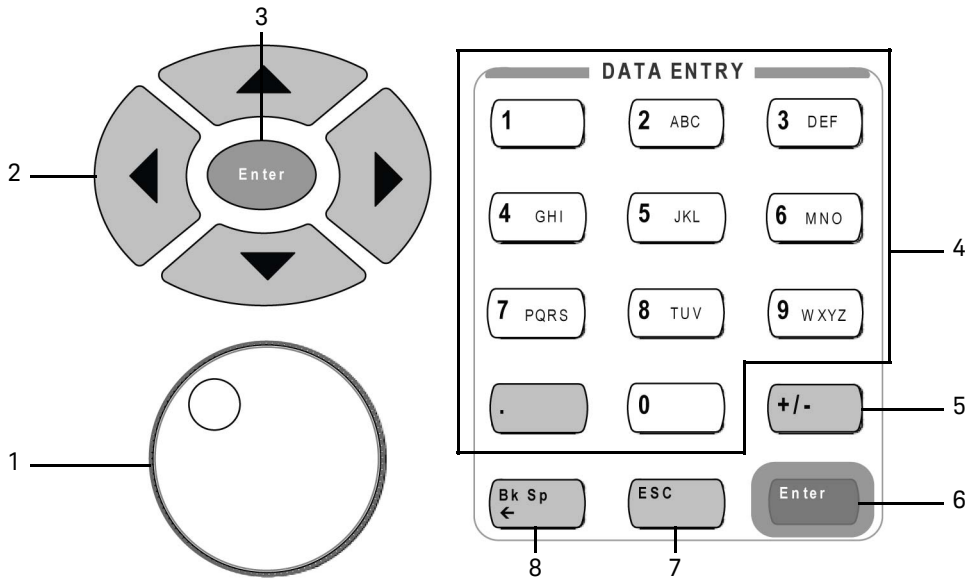

Figure 1-7 Editing keys

Table 1-5 Editing keys description

No	Item	Description
1	Knob	The usage of the knob are as follows. <ul style="list-style-type: none">- Increases or decreases a numeric value- Changes a highlighted digit or character- Navigates through lists or items in a row- Moves the marker along the graph plot
2	Arrow keys	The usage of the up and down arrow keys are as follows. <ul style="list-style-type: none">- Highlights the active channel- Increases or decreases a highlighted digit or value of the current measurement selection- Navigates within tables The usage of the left and right arrow keys are as follows. <ul style="list-style-type: none">- Selects the channel number- Navigates the editable items on the LCD display for editing- Navigates within tables
3	Enter	Confirms an entry and then terminates data entry when the default unit is used
4	Numeric keys	Enter alphanumeric data by using the number keys and decimal point
5	+/-	Specifies a positive or negative value. For a negative value, toggle this key to enter the negative sign before a numeric value.
6	Enter	Confirms an entry
7	Esc	<ul style="list-style-type: none">- Cancels a selected action- Deactivates the Help mode
8	Bk Sp	Deletes the selected data entry

Switching to 2-Panel or 4-Panel View

Toggle **Display Mode** to display either 2-panel view or 4-panel view as shown in [Figure 1-8](#) and [Figure 1-9](#).

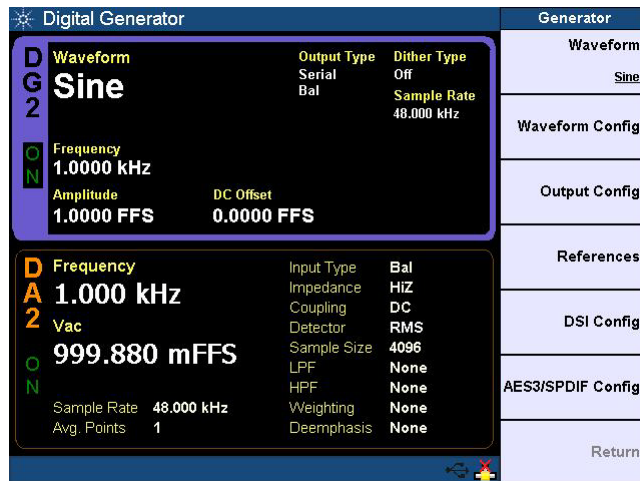

Figure 1-8 2-panel view display



Figure 1-9 4-panel view display

Switching to Generator/Analyzer and Analog/Digital Mode

Press **Generator** on the Mode panel to change the selected display screen to the generator mode or toggle between analog generator or digital generator.

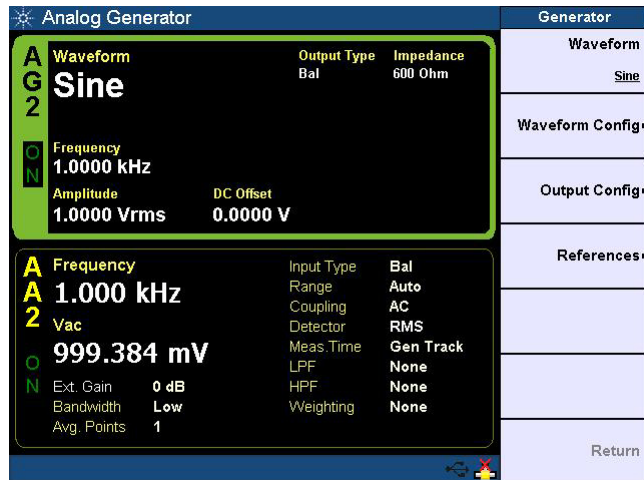

Figure 1-10 Analog generator

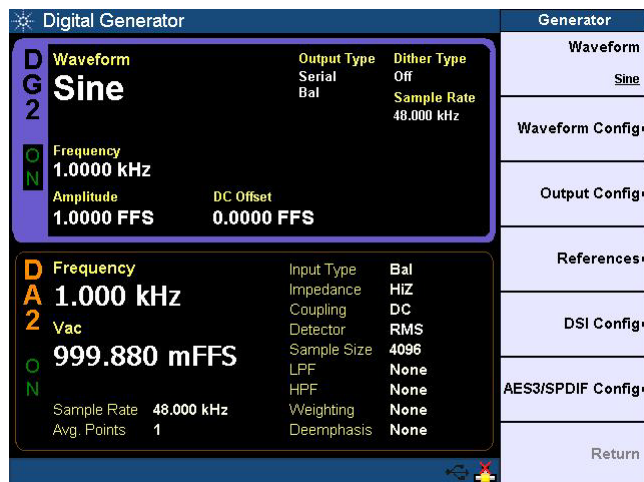

Figure 1-11 Digital generator

Press **Analyzer** on the Mode panel to change the selected display screen to the analyzer mode or toggle between analog analyzer or digital analyzer.

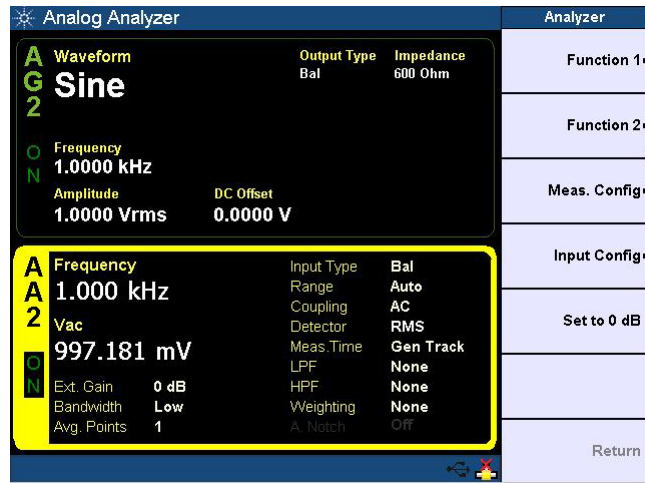

Figure 1-12 Analog analyzer

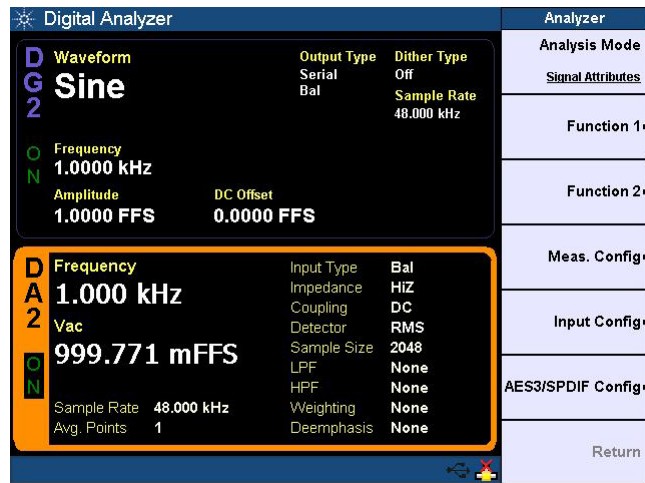

Figure 1-13 Digital analyzer



This information is subject to change without notice. Always refer to the Keysight website for the latest revision.

© Keysight Technologies 2011–2016
Edition 8, April 1, 2016

Printed in Malaysia



U8903-90032

www.keysight.com